

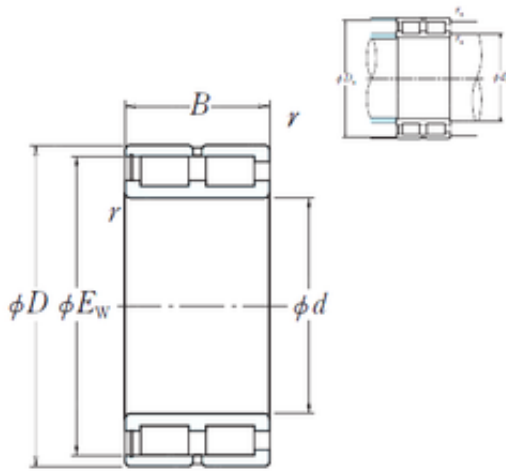

NNCF4892V NSK CYLINDRICAL ROLLER BEARING

Bearing No. NNCF4892V



NNCF4892V Bearing 2D drawings and 3D CAD models

Size	460x549.2x118 mm
Bore Diameter	460 mm
Outer Diameter	549,2 mm
Width	118 mm
d	460 mm
D	580 mm
Ew	549,2 mm
B	118 mm
C	118 mm
r min.	3 mm
Da	555 mm
ra max.	2,5 mm
da	483 mm
Weight	77,5 Kg
Basic dynamic load rating (C)	1730 kN